

# WIPROBET

Sp. j. B.T. Gryczewscy

PŁYTY CHODNIKOWE I OBRZEŻA | WYROBY SZARE I KOLOROWE

## PŁYTKA CHODNIKOWA

- z fazyą
- bez fazy

## INFUA

- z fazyą
- bez fazy

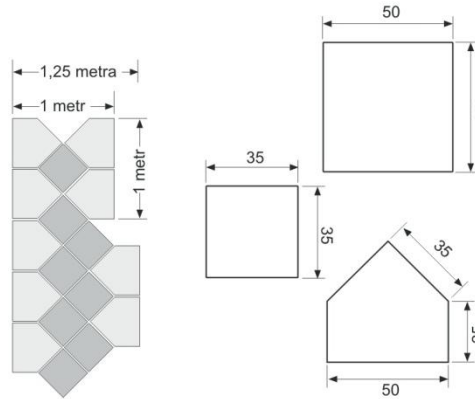
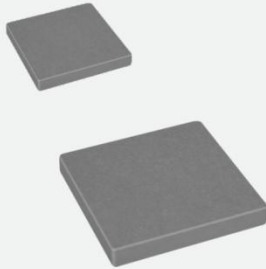

Rodzaj	Wymiary	Ilość elem. na m <sup>2</sup>	Waga elementu
prosta	35x35x5	8,16	14,5 kg
	35x35x6	8,16	17 kg
infua	50x35x25x5	5,4	24 kg
	50x35x25x6	5,4	26 kg
prosta	50x50x7	4	43 kg

## PŁYTA AŻUROWA

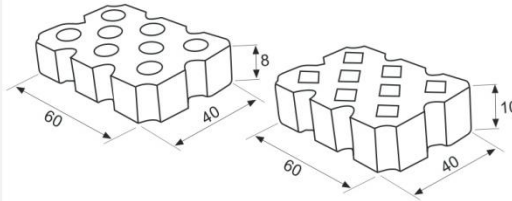

Wymiary	Ilość elementów na m <sup>2</sup>	Waga elementu
60x40x8	4,16	28 kg
60x40x10	4,16	32,50 kg

## PŁYTA ŚCIEKOWA KORYTKOWA

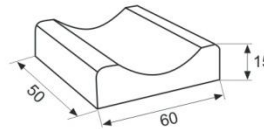
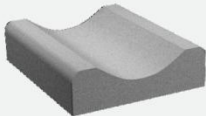

Wymiary	Ilość elementów na palecie	Waga elementu
60x50x15	12	82 kg

## PŁYTA ŚCIEKOWA TRÓJKĄTNA

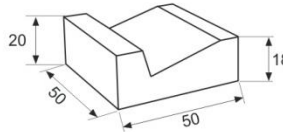
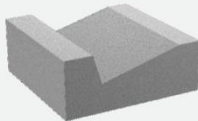

Wymiary	Ilość elementów na palecie	Waga elementu
50x50x20x18	8	93 kg

## OBRZEŻA CHODNIKOWE

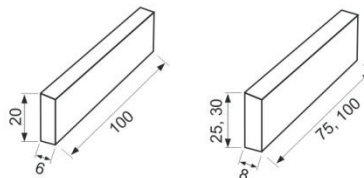

Wymiary	Ilość elementów na palecie	Waga elementu
100x6x20	45	27 kg
100x8x25	24	45 kg
100x8x30	24	55 kg
75x8x25	24	34 kg

## OBRZEŻA CHODNIKOWE ŁUKOWE

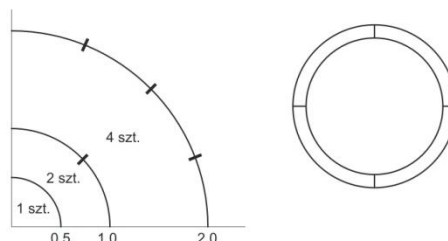

Wymiary	Promień	Waga elementu	Długość łuku	Ilość sztuk na okrąg
6x20	0,5 m	22 kg	82 cm	4
	1 m	22 kg	80 cm	8
	2 m	22 kg	80 cm	16
8x25	0,5 m	40 kg	85 cm	4
	1 m	40 kg	80 cm	8
	2 m	40 kg	80 cm	16

**PROSTE**

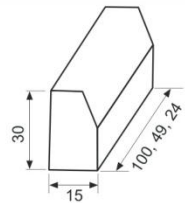
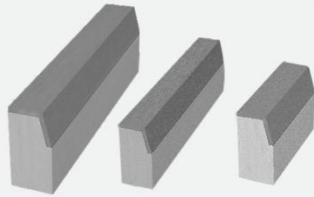

Wymiary	Ilość elementów na palecie	Waga elementu
100x15x30	12	100 kg
49x15x30	24	49 kg
24x15x30	42	24 kg

**ŁUKOWE**

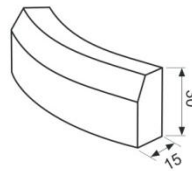
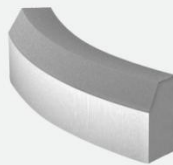

Promień	Waga elementu	Długość łuku	Ilość sztuk na 1/4 okręgu
0,5 m	73 kg	73 cm	1
1 m	75 kg	80 cm	2
3 m	75 kg	82 cm	6
5 m	80 kg	82 cm	10

**NAJAZDOWE**

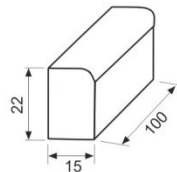

Wymiary	Ilość elementów na palecie	Waga elementu
100x15x22	18	80 kg

**NAJAZDOWE SKOŚNE**

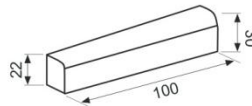
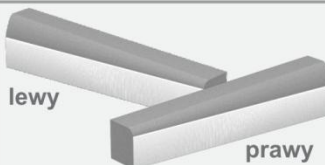

Wymiary	Ilość elementów na palecie	Waga elementu
100x15x30x22	12	92 kg

**PROSTE**

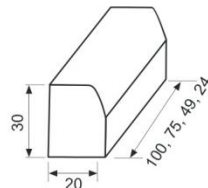
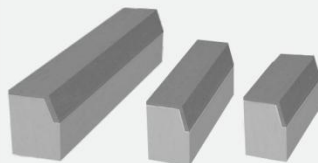

Wymiary	Ilość elementów na palecie	Waga elementu
100x20x30	10	135 kg
75x20x30	10	100 kg
49x20x30	20	66 kg
24x20x30	36	33 kg

**ŁUKOWE**

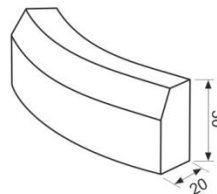
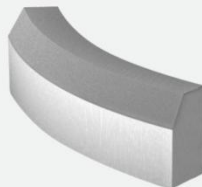

Promień	Waga elementu	Długość łuku	Ilość sztuk na 1/4 okręgu
0,5 m	94 kg	80 cm	1
6 m	98 kg	82 cm	11

**NAJAZDOWE**

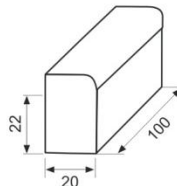

Wymiary	Ilość elementów na palecie	Waga elementu
100x20x22	15	98 kg

**NAJAZDOWE SKOŚNE**

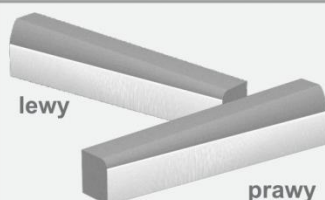

Wymiary	Ilość elementów na palecie	Waga elementu
100x20x30x22	10	122 kg

# WIPROBET

Sp. j. B.T. Gryczewscy

ELEMENTY ARCHITEKTURY OGRODOWEJ | WYROBY SZARE I KOLOROWE

Gazon  
OKRĄGŁY Ø 35  
28x25

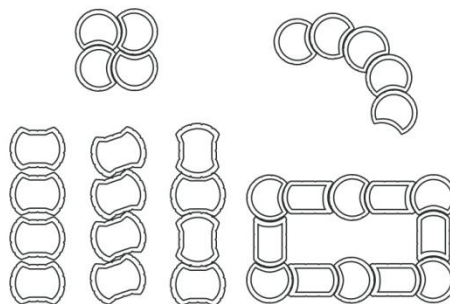
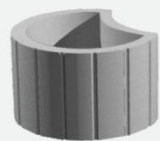

Kształt	Ilość elem. na 1 mb	Wysokość	Waga elementu
okrągły 28x25	3,5	25	21 kg
owalny 40x25	2,5	25	24 kg
Julia 50x30	2	30	48 kg

Gazon  
OWALNY Ø 24  
40x25

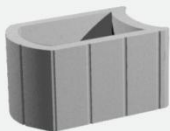

Gazon  
JULIA 50x30

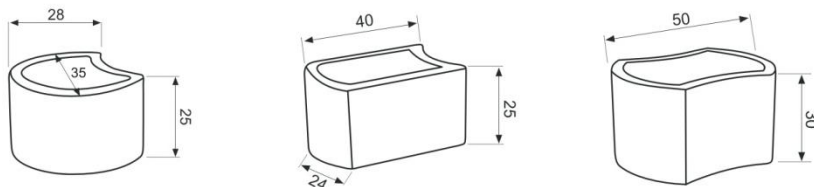
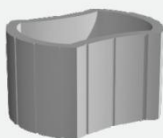

PALISADA NOSTALIT  
-PROSTA  
-TRAPEZOWA

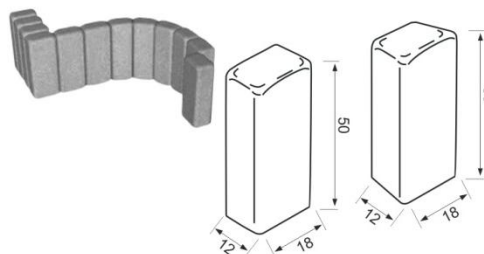

Wymiary	Ilość elementów na palecie	Waga elementu
50x18x12	48 prosta	24 kg
	60 trapez	

STOPNIE  
SCHODOWE

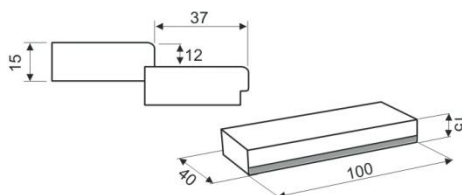
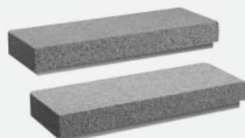

Wymiary	Ilość elementów na palecie	Waga elementu
100x40x15	12	140 kg

FUNDAMENT  
SŁUPKA

OBRZEŻE  
MIĘDZYPRZĘSŁOWE

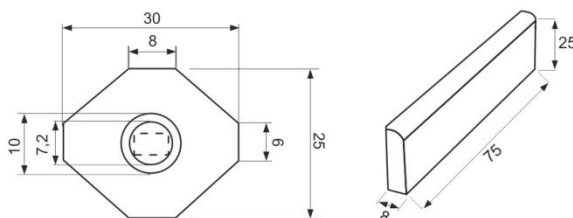

Wymiary	Waga elementu
75x25x8	33 kg
30x25x50	51 kg

COKÓŁ  
BETONOWY

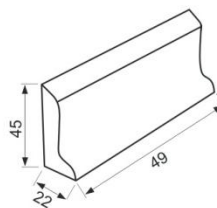
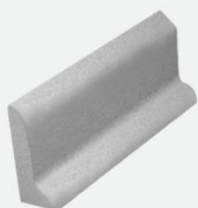

Wymiary	Ilość elementów na palecie	Waga elementu
49x45x22	10	60 kg